

All Systems Interconnect Cables to be supplied by others

KW	Input Voltage	Utility Feed Amps
12.0	208Y/120	58.4
	480Y/277	25.3
	208	58.4
	480	25.3
16.0	208Y/120	77.8
	480Y/277	33.7
	208	77.8
	480	33.4
20.0	208Y/120	97.3
	480Y/277	42.1
	208	97.3
	480	42.1
24.0	208Y/120	116.7
	480Y/277	50.6
	208	116.7
	480	50.6
30.0	208Y/120	145.9
	480Y/277	63.2
	208	145.9
	480	63.2

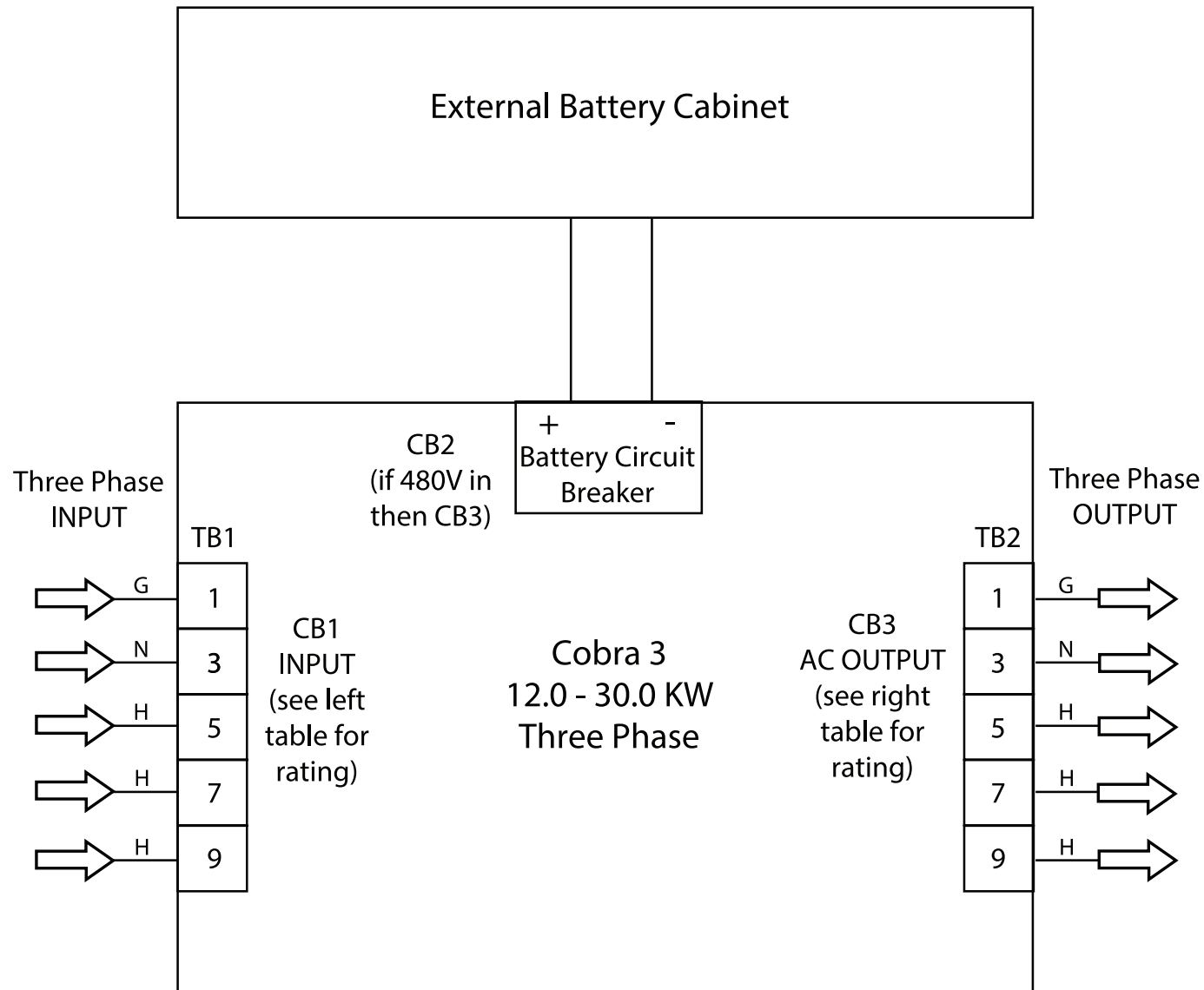

KW	Output Voltage	Max Output Amps
12.0	208Y/120	33.3
	480Y/277	14.5
16.0	208Y/120	44.5
	480Y/277	19.3
20.0	208Y/120	55.6
	480Y/277	24.1
24.0	208Y/120	66.7
	480Y/277	28.9
30.0	208Y/120	83.4
	480Y/277	36.1