

KW	Input Voltage	Utility Feed Amps
12.0	120	175
	208	101
	240	87.5
	277	76
	480	43.8
14.0	120	204.2
	208	118
	240	102
	277	88.5
	480	51
18.0	120	262.5
	208	151.5
	240	131.3
	277	113.8
	480	65.6
21.0	120	306.3
	208	176.7
	240	153
	277	132.7
	480	76.6

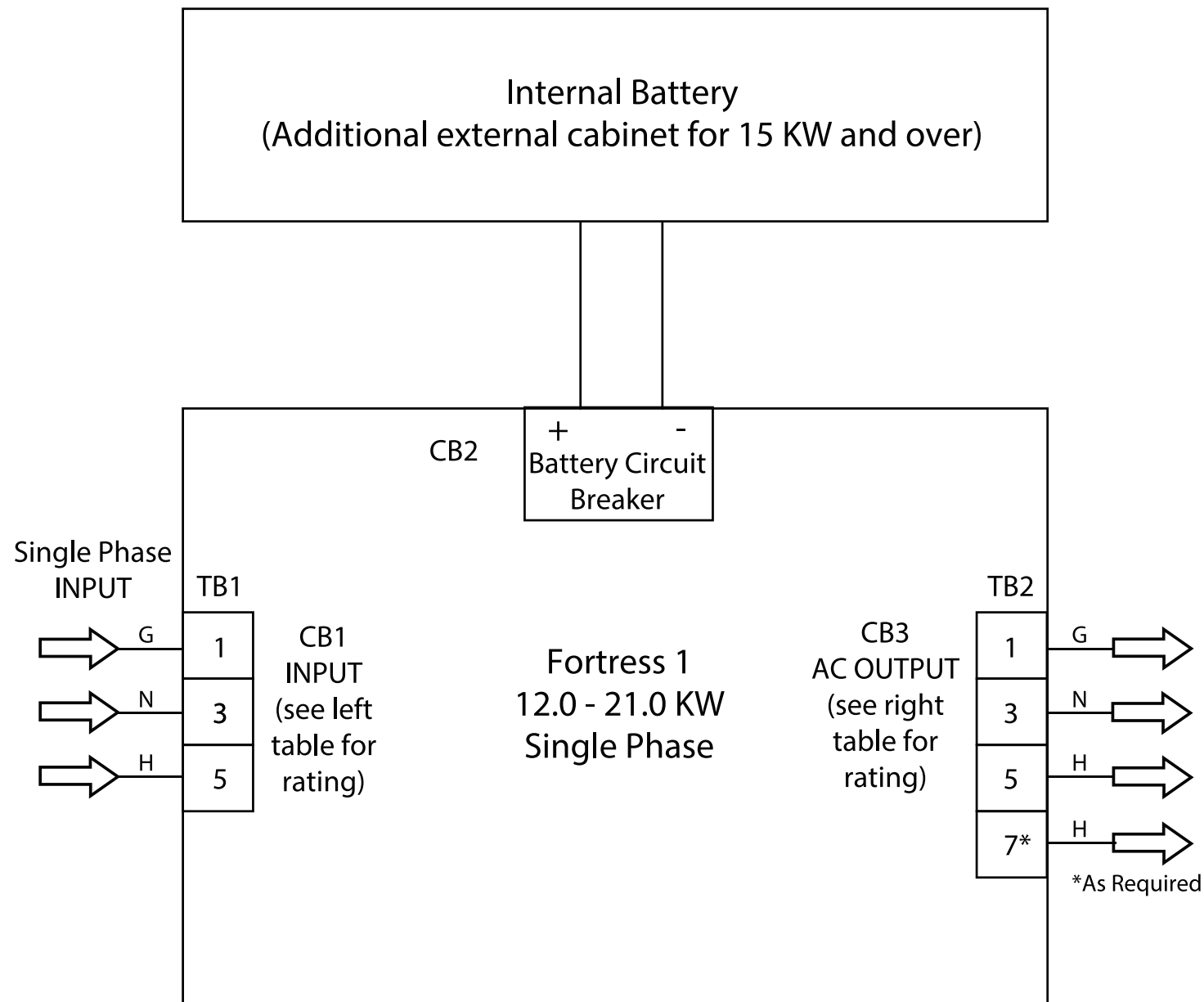

KW	Output Voltage	Max Output Amps
12.0	120	100
	277	43.4
	480	25
	120/240*	100/50
	120/277*	100/43.4
14.0	120	116.7
	277	50.6
	480	29.2
	120/240*	116.7/58.4
	120/277*	116.7/50.6
18.0	120	150
	277	65
	480	37.5
	120/240*	150/75
	120/277*	150/65
21.0	120	175
	277	75.8
	480	43.8
	120/240*	175/87.5
	120/277*	175/75.8